

# servomold®



## Operating Instructions Servo Control System SKS-4.1 / 4.2 / 4.3

© 2022 Servomold GmbH & Co.KG

Operating Instructions Version 6.0.0  
Servo Control System  
SKS-4.1 / 4.2 / 4.3  
store for future use

**Copyright information**

The information in this document is regularly checked for accuracy and timeliness, and is subject to change without prior notice.

All contents of this documentation, including text, photographs and graphics are copyrighted. The copyright is, unless expressly stated otherwise at Servomold GmbH & Co.KG.

Please contact us if you intend on using the content of this documentation.

Translation into other languages is not permitted without prior written consent from Servomold GmbH & Co.KG.

**Limited warranty:**

The content of this documentation has been carefully developed and tested.

Servomold GmbH & Co.KG assumes no responsibility for any damage that may arise from errors in the documentation. In particular descriptions and technical specifications are not warranted characteristics in the legal sense.

Servomold GmbH & Co.KG has the right to make changes to the product described or documentation without prior notice, if they are made for reasons of reliability and quality assurance, or by technical progress.

Erbach, 01.02.2022

**Servomold GmbH & Co.KG**

Gewerbepark Gräsig 72

64711 Erbach

Germany

Phone: +49 6062 80933-0

Fax: +49 6062 80933-30

email: [info@servomold.com](mailto:info@servomold.com)

[www.servomold.com](http://www.servomold.com)

# Declaration of conformity

EC Declaration of conformity according to

- Annex II of the Low Voltage Directive 2006/95/EC
- Annex IV 2. of the EMC Directive 2004/108/EC
- Annex IV 2. of the RoHS Directive 2011/65/EU

We

**Servomold GmbH & Co.KG**

Gewerbepark Gräsig 72  
64711 Erbach  
Germany

Phone: +49 6062 80933-0

Fax: +49 6062 80933-30

email: [info@servomold.com](mailto:info@servomold.com)

[www.servomold.com](http://www.servomold.com)

declare that the following product:

Servo Control System

Type: SKS-4.1 / 4.2 / 4.3

in the version delivered by us meets the requirements of the following directives

- Low Voltage Directive 2006/95/EC
- EMC Directive 2004/108/EC
- RoHS Directive 2011/65/EU

.

The following harmonised standards have been applied:

EN 60204-1:2006 + A1:2009

EN ISO 13850:2008

EN 61000-6-1:2007

EN 61000-6:3:2007

EN 50581:2011

The last two digits of the year in which the CE labeling was attached: 11



Erbach, 01.02.2022

*Place and date of the declaration*

Managing Director Thomas Meister,

*Particulars of the authorized person, signature*

# Content

<b>1</b>	<b>Introduction</b>	<b>6</b>
1.1	General information .....	7
1.2	Disclaimer .....	8
<b>2</b>	<b>Safety</b>	<b>9</b>
2.1	Graduated safety information .....	10
2.2	Intended use .....	11
2.3	Emission sound pressure level .....	12
2.4	General description of the machine .....	12
2.4.1	Residual risks .....	12
2.4.2	Safety equipment .....	13
2.4.2.1	Supply circuit disconnecting means.....	13
2.4.2.2	Housing .....	14
2.4.2.3	Emergency Stop Device.....	14
2.4.2.4	Warning signs.....	14
2.4.3	Workplaces .....	14
2.5	Authorized operating staff .....	16
2.5.1	Operator .....	18
2.5.2	Setter .....	19
2.5.3	Main setter .....	19
2.5.4	Commissioning staff .....	20
2.5.5	Assembly and maintenance staff .....	21
2.6	Handling .....	21
2.6.1	Transport .....	21
2.7	Disposal .....	22
2.8	Emergency, extinguishing materials .....	22
<b>3</b>	<b>Machine description</b>	<b>23</b>
3.1	Function .....	25
3.2	Electrical connections .....	25
3.3	USB interface .....	26
<b>4</b>	<b>Operation</b>	<b>27</b>
4.1	Main operating modes .....	28
4.2	Switch on and login .....	30

4.3 Loading program .....	32
4.4 Homing .....	33
4.5 Manual mode .....	34
4.6 Automatic mode .....	35
4.7 Switching off .....	36
<b>5 Faults</b>	<b>37</b>
5.1 Types of faults .....	38
5.2 Reset faults .....	40
<b>6 Maintenance</b>	<b>42</b>
6.1 Maintenance plan .....	43
6.2 Error list .....	44
<b>7 Spare parts</b>	<b>45</b>
<b>Index</b>	<b>47</b>

# Chapter

# 1

# 1 Introduction

With the Servo Control System you have purchased an all-in-one control system which we have developed according to the best available technology.

The Servo Control System offers you universal application possibilities for the control of servo actuators and impresses with the following advantages:

- Extremely repeatable rotating and linear movements
- Torque and speed precisely and individually controllable
- Complex rotary and linear movements can be combined
- Control is individually configurable and programmable
- Torque limits on control can be monitored
- The simplest operation via touchscreen
- Reliable and safe because the control with integrated safety technology (Emergency stop and protective doors)
- Meets protective category IP32
- Independent and flexible because it can be used universally on almost all common injection molding machines
- LED lights for signaling the operating modes

## 1.1 General information

These Operating Instructions describe the operation of the Servo Control System at the operator level 4 (setter). The Operating Instructions contain the technical data as well as information on the intended use. Information on assembly, programming and maintenance are not covered in these Operating Instructions.

**Please read these Operating Instructions carefully prior to using the Servo Control System.**

**Keep the Operating Instructions in a safe place for later use.**

**In case the Servo Control System is moved to another location, these Operating Instructions are to be handed over together with the Servo Control System to the new operator.**

**If the Servo Control System is moved to another location in a country outside of Europe, the relevant national safety regulations of the country of destination must be observed!**

**Contact the manufacturer Servomold GmbH & Co.KG if the machine is to be moved to a country outside of Europe.**

Only use the Servo Control System when you fully understand all safety regulations and the operation of the Servo Control System. If you would like more information, please contact the manufacturer Servomold GmbH & Co.KG.

In the Operating Instructions, the following different colored notice on the explanation of equipment and functions as well as the need for an action are used:

*This remark gives explanations on equipment and functions as well as displays on the touchscreen*

*This remark will prompt you to press a button on the control panel or on the touch screen or to enter a value*

## 1.2 Disclaimer

Compliance with the Operating Instructions is the basic requirement for the safe operation of the Servo Control System and to achieve the specified product properties and performance features. Servomold GmbH & Co.KG assumes no liability for injury, property damage or pecuniary losses incurred due to non-observance of these Operating Instructions. The liability for material defects is excluded in such cases.



# Chapter

# 2

## 2 Safety

The Servo Control System has been designed and built by us for safety and has left the plant in a technically and operationally safe condition. It has the protection category IP32 and meet the requirements of both the Low Voltage Directive 2006/95/EC and the Directive 2004/108/EC from 15 December 2004 (EMC Directive)

To maintain this condition and to ensure safe operation, the user must observe the instructions and warnings contained in these Operating Instructions and the safety instructions.

Because compliance with the safety regulations is beyond our control, no liability for damages can be assumed which result from non-compliance with one or more of these regulations.

The list of applicable safety regulations cannot be comprehensive (German and foreign machine regulations). Failure to include one of these regulations in the list does not mean that is not applicable.

Commissioning, maintenance and repairs should only be carried out by persons who are recognized in accordance with legal requirements as skilled workers and are not covered in these Operating Instructions.

### 2.1 Graduated safety information

Warnings and notices are labeled in these Operating Instructions by a symbol with a SIGNAL WORD!

The warnings and notices are printed in bold and highlighted with a frameline.

The warning notices are ranked hierarchically and are arranged according to the SAFE method. The acronym **SAFE** stands for the four principles:

- **S**eriousness of the danger(SIGNAL WORD!)
- **A**- type and source of the danger
- **F**ailure to follow the instructions leads to dangerous results
- **E**scape (Measures to avert the danger)

	<b>DANGER!</b>	The key word <b>DANGER</b> is used when warning of a <b>directly threatening danger</b> . <b>The immediate consequences are death or serious injuries (personal bodily injuries).</b>
<ul style="list-style-type: none"> <li>• Observe the warnings and safety instructions!</li> </ul>		

	<b>WARNING!</b>	The key word <b>WARNING</b> is used when warning of a <b>possible danger</b> . <b>The possible consequences could be death or serious injuries (personal bodily injuries).</b>
<ul style="list-style-type: none"> <li>• Observe the warnings and safety instructions!</li> </ul>		

	<b>CAUTION!</b>	The key word <b>CAUTION</b> is used when warning of a <b>possible danger</b> . <b>The possible consequences could be slight or minor injuries (personal bodily injuries).</b>
<ul style="list-style-type: none"> <li>• Observe the warnings and safety instructions!</li> </ul>		

	<b>NOTICE!</b>	The key word <b>NOTICE</b> is used when warning of a <b>damage to property</b> . <b>The possible consequences of non-observance could be damage, e.g. to the machine or material or environmental damage.</b>
<ul style="list-style-type: none"> <li>• Observe the warnings and safety instructions!</li> </ul>		

	<b>INFO</b>	<p>The key work <b>INFO</b> refers to information for operation, programming and handling of the device.</p> <p><b>This information aids in the prevention of errors and gives tips on the use of the device.</b></p>
<ul style="list-style-type: none"> <li>Observe the notices on operation, programming and handling of the device!</li> </ul>		

## 2.2 Intended use

The Servo Control System has only been designed and produced to control servo drives of the manufacturer Servomold GmbH & Co.KG. Drives may only be used by third parties with the prior permission of Servomold GmbH & Co.KG.

### Non-intended use:

- The Servo Control System may not be used in potentially explosive atmospheres.
- The Servo Control System may not be used outside of the safe zone of a machine aside from the functional inspection during the installation or reinstallation (special operating mode process observance)!

	<b>WARNING!</b>	<p><b>Danger from misuse of Servo Control System</b></p> <p><b>The consequences of a non-intended use may result in loss of life, personal injuries, material damage or environmental impairments.</b></p>
<ul style="list-style-type: none"> <li>Only use the Servo Control System for the purposes intended especially within the specified limit values!</li> <li>Observe the maintenance information and only use original spare parts from Servomold GmbH &amp; Co.KG!</li> <li>The operator alone assumes the liability for any damages which result from an improper use of the Servo Control System!</li> </ul>		

Limit values of the ambient conditions	min.	max.
Ambient temperature of air	5°C	40°C
Relative humidity of the surroundings	10%	90%, Operation only in conditions where there is no condensation or ice
Altitude	--	2000 m above NN
Setup location (contamination)	Weather protected site, e.g. not fully air conditioned operation space (contamination level 3)	
Transport and storage	-20°C	55°C

Table 1 Limit values of the ambient conditions for Servo Control System

The Servo Control System has been designed and built by us for safety.

	<b>NOTICE!</b>	<p><b>Danger from modifications and retrofitting</b></p> <p><b>The possible consequences may be damage to property or environmental impairment.</b></p>
<ul style="list-style-type: none"> <li>Do not undertake any modifications or retrofitting on the Servo Control System yourself!</li> <li>Do not perform retrofits with accessories or equipment from other manufacturers, before consulting with Servomold GmbH &amp; Co.KG especially regarding the suitability of these parts!</li> <li>Modifications or attachments without the prior express written approval of Servomold GmbH &amp; Co.KG will result in the loss of warranty rights!</li> </ul>		

The Servo Control System is low maintenance, but not maintenance-free.

	<b>NOTICE!</b>	<b>Maintenance</b> <b>The consequences of irregular maintenance can be damage to the machine and production downtime.</b>
<ul style="list-style-type: none"> <li>• Observe the maintenance information!</li> </ul>		

If the Servo Control System is not commissioned immediately after delivery, it must be carefully stored in a protected location.

The minimum and maximum storage temperature is:

" min.: -20 °C

" max.: 55 °C

Shiny, blank machine parts have been coated with a corrosion protection at the factory. This protective coating is good for about two months.

	<b>NOTICE!</b>	<b>Corrosion protection</b> <b>Corrosion can cause damage to property.</b>
<ul style="list-style-type: none"> <li>• Check and if necessary, reapply corrosion protection monthly during storage!</li> </ul>		

## 2.3 Emission sound pressure level

The A-rated equivalent emission sound pressure level is <70 dB(A) during the automatic operating mode at all workplaces.

## 2.4 General description of the machine

In this chapter, you will receive information on the safety devices in the Servo Control System .

### 2.4.1 Residual risks

The Servo Control System has been designed and built according to the basic safety requirements of the EC Machinery Directive.

	<b>WARNING!</b>	<b>There is a danger of residual risks</b> <b>The consequences of misuse or improper operation can be serious injuries as well as property and environmental damages.</b>
<ul style="list-style-type: none"> <li>• Read and observe these Operating Instructions!</li> <li>• Only qualified, trained and skilled workers may work on or with the Servo Control System!</li> <li>• Observe the warnings and safety instructions!</li> </ul>		

	<b>WARNING!</b>	<p><b>Danger from misuse of Servo Control System</b></p> <p>The consequences of a non-intended use may result in loss of life, personal injuries, material damage or environmental impairments.</p>
<ul style="list-style-type: none"> <li>• Only use the Servo Control System for the purposes intended especially within the specified limit values!</li> <li>• Observe the maintenance information and only use original spare parts from Servomold GmbH &amp; Co.KG!</li> <li>• The operator alone assumes the liability for any damages which result from an improper use of the Servo Control System!</li> </ul>		

## 2.4.2 Safety equipment

The Servo Control System is equipped with safety equipment which enables a safe setup, operation and maintenance of the device. This includes:

- A supply circuit disconnecting means (mains switch)
- Housing
- An emergency stop device (safety relays)
- Warning signs

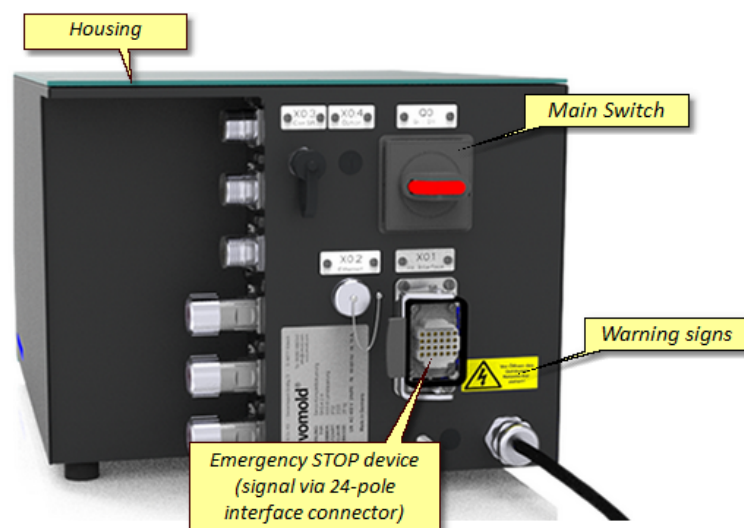



Fig. 1 Safety equipment on the Servo Control System

	<b>WARNING!</b>	<p><b>Electrical and mechanical dangers</b></p> <p>Electrical current or mechanical movements can kill or seriously injure you.</p>
<ul style="list-style-type: none"> <li>• The Servo Control System may only be used with the housing closed!</li> </ul>		

### 2.4.2.1 Supply circuit disconnecting means

The Servo Control System has a lockable supply circuit disconnecting means.

The black labeled supply circuit disconnecting means (mains switch) is located on the back of the device.



Fig. 2 Supply circuit disconnecting means (mains switch) on the Servo Control System

### 2.4.2.2 Housing

The Servo Control System is equipped with a housing according to protection category IP32. The housing prevents the touching of live parts.

### 2.4.2.3 Emergency Stop Device

The Servo Control System has an emergency stop device (2 channels, Save-Torque-Off, STO).

The safety devices (2 channels) and the emergency stop devices (2 channels) of the machine, which are driven within their safe zones with the Servo Control System controlled servo drives, are evaluated in with the help of two safety relay modules (each 2-channel) in order to produce a safe stop.

### 2.4.2.4 Warning signs

Warning signs on the Servo Control System point out the residual hazards:



Warning signs	Importance	Where?
	Warning of dangerous electrical voltage	Control
	Warning of hot surfaces	Motor housing Transmission housing

Table 2 Warning signs on the Servo Control System

### 2.4.3 Workplaces

	<b>CAUTION!</b>	<p><b>Misuse or unkempt workplaces</b> The possible consequences may be minor injuries (personal damage), damage to property or environmental impairment.</p> <ul style="list-style-type: none"> <li>• Clean the workplaces regularly!</li> <li>• Keep the workplaces free of objects which are not or no longer needed at the workplaces.</li> </ul>
-------------------------------------------------------------------------------------	-----------------	-----------------------------------------------------------------------------------------------------------------------------------------------------------------------------------------------------------------------------------------------------------------------------------------------------------------------------------------------------------

## Safety

The Servo Control System has a workplace.

Workplace	Workplace area	Workplace designation	Tasks
1	Controller rear side	Line disconnecter	Controller Switch on/Switch off
	Controller front side	Control panel	Switch drive on/off (One-zero button) if needed, move drive using manual mode (Plus-Minus button) Operate and parametrize controller (Touchscreen) among other things: - Start reference run - Select operating mode Automatic - Start automatic mode

Table 3 Workplaces on the Servo Control System .

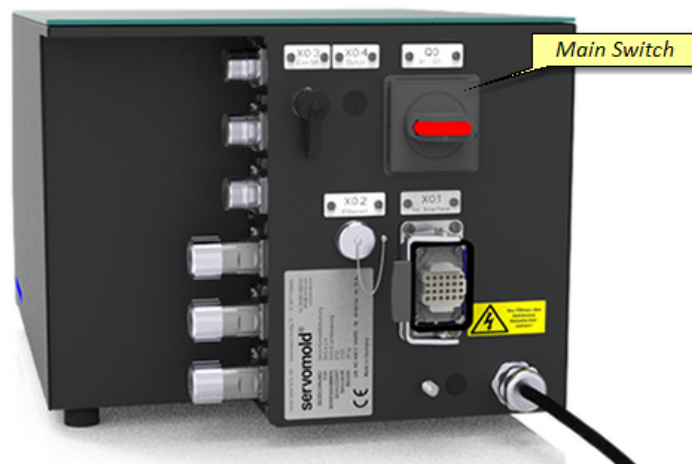

Fig. 3 Workplace mains switch on the Servo Control System .

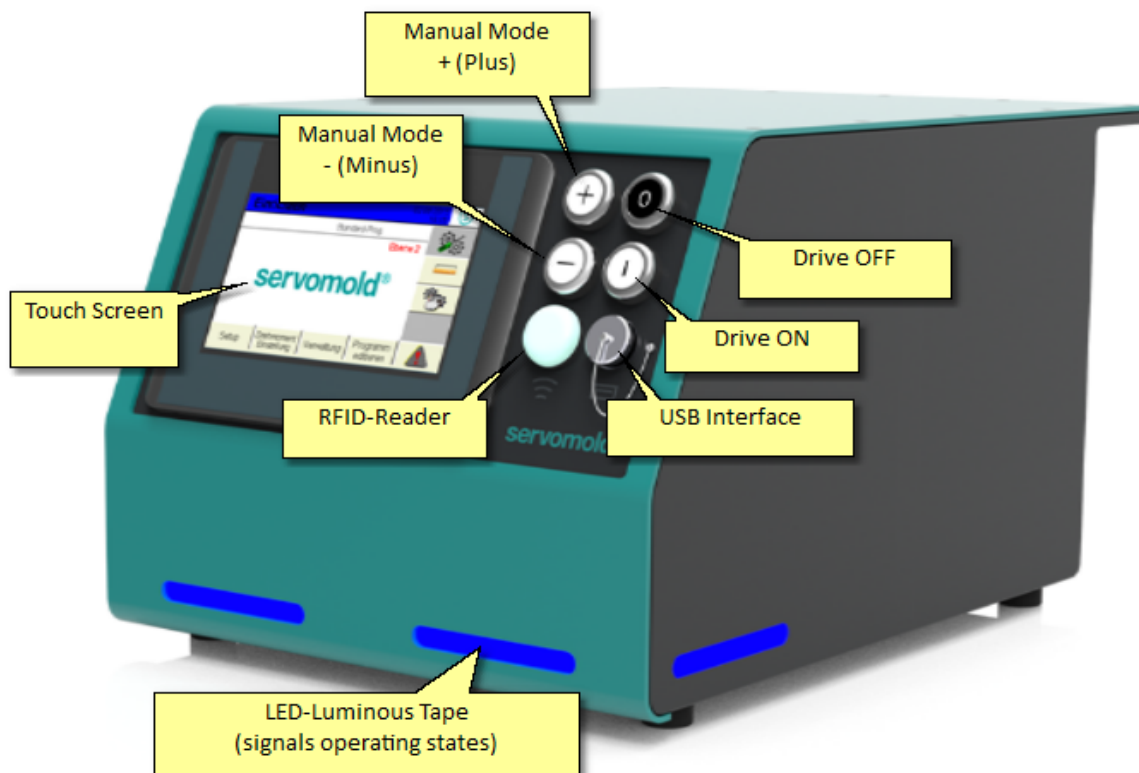

Fig. 4 Workplace control panel on the Servo Control System >.

## 2.5 Authorized operating staff

Only qualified, knowledgeable skilled workers may work with the Servo Control System .

	<p><b>CAUTION!</b></p>	<p><b>Danger from inadequately trained staff</b>  <b>Inadequately trained or qualified staff endanger themselves or others. The possible consequences can be minor injuries, damage to property or environmental impairment.</b></p>
<ul style="list-style-type: none"> <li>• Only qualified, trained and skilled workers may work on or with the Servo Control System!</li> <li>• No unauthorized people may have access!</li> <li>• Changing and handling of the application software may only be done by staff authorized and trained for this (commissioning staff or head fitter)!</li> <li>• Only qualified technicians may carry out maintenance and service work!</li> <li>• Repairs and error eliminations may only be carried out by the manufacturer or knowledgeable people!</li> </ul>		



## Safety

In order to ensure that only authorized people have access to the corresponding functions as well as user levels, the various user levels are protected by passwords.

The following user levels are available:

Level	Operator	Explanation
0	Manufacturer	Blocked for customers/Basic settings of the manufacturer
1	Manufacturer	Blocked for customers/Basic settings of the manufacturer
2	Commissioning staff	<b>Special operating mode (process monitoring mode):</b> <ul style="list-style-type: none"> <li>• All settings possible</li> <li>• Operation is possible also without active safety technology! Observe the danger information!</li> </ul>
3	Main setter	<b>Extended setup mode:</b> <ul style="list-style-type: none"> <li>• Full access to setups, reference runs, manual mode and automatic mode</li> <li>• Can create, edit, read and save programs</li> <li>• Can move individual axis via jog mode.</li> </ul>
4	setter	<b>Setup mode:</b> <ul style="list-style-type: none"> <li>• Fully access to reference run and automatic</li> <li>• Restricted access to setups and manual mode</li> <li>• Can read programs, no change options to program sequence</li> <li>• Can reset faults</li> </ul>
5	Operator	<b>Operating mode 1:</b> <ul style="list-style-type: none"> <li>• Full access to automatic</li> <li>• Restricted access to setups and manual mode</li> <li>• No access to reference run</li> <li>• No change options on program sequence, no reading of programs</li> </ul>
6	Operator	<b>Operating mode 2:</b> <ul style="list-style-type: none"> <li>• Restricted access to setups and automatic</li> <li>• No access to reference run or manual mode</li> <li>• No change options on program sequence, no acknowledging of faults, no reading of programs</li> </ul>

When starting the controller is set at the user level 4 (setter).

	<b>WARNING!</b>	<b>Moving machine parts</b> Loose clothing, long hair, jewelry chains or similar can get caught in machinery and pulled in during Troubleshootinges, repairs or function testing and lead to serious injuries.
<ul style="list-style-type: none"> <li>• Only work with closely fitting clothing!</li> <li>• Keep long hair under a head covering!</li> <li>• Never wear jewelry (e.g. chains, rings, etc.)!</li> </ul>		

	<b>CAUTION!</b>	<b>Danger from aging, outer impacts, changes</b> <b>The consequences can be minor injuries, damage to property or environmental impairment.</b>
<ul style="list-style-type: none"> <li>• Check the Servo Control System prior to each work flow for safety and only operate it in flawless conditions!</li> <li>• Have any safety defects eliminated by a qualified technician immediately!</li> <li>• Only operate the Servo Control System with a closed housing!</li> <li>• Make sure that no people can be injured or endangered by the running Servo Control System before switching on!</li> <li>• Never reach into the Servo Control System after triggering the movement procedure or while the machine is in automatic mode!</li> </ul>		

## 2.5.1 Operator

**The operator is a trained and sufficiently qualified person.**

The operator

- operates the Servo Control System
- switches the mains switch on and off if needed.
- switches the drives on and off
- selects the operating mode
- starts the automatic mode
- controls the work sequence
- moves the drives in the restricted manual mode according to the specified program (extending, extending) (operator 1)
- eliminates faults in the daily work flow if needed
- carries out external cleaning work on secured, shutdown Servo Control System

If desired, the operator can set the user level 5 (Level 5) by entering a password

. At the user level 5, there is full access to the functions of the automatic mode (start and stop of the automatic) as well as a restricted access to the manual mode.

## 2.5.2 Setter

**The setter is a special authorized and trained person.**

The setter

- operates the Servo Control System
- switches the line disconnecter on and off
- enters the password for the user level 4 (Leuvel 4)
- loads programs from the internal program memory
- selects the operating mode
  - Reference run
  - Semi-automatic
  - Administration
- switches the drives on and off
- starts the reference run if needed
- moves the drives in restricted manual mode according to the prescribed program (extending, retracting)
- selects the operating mode
- starts the automatic mode
- controls the work sequence
- eliminates faults in the daily work flow if needed
- resets faults
- carries out external cleaning work on secured, shutdown Servo Control System

## 2.5.3 Main setter

**The Main setter is a trained and specially authorized person.**

The Main setter

- enters the password for the user level 3 (Level 3)
- generates the program (program sequences)
- administers programs internally or via USB stick
- programs the process parameters (e.g. speeds, acceleration, delay)
- parametrizes the Servo Control System

The Main setter has access to the listed tasks at all levels for which the setter has access.

**The program generation and parametrization is not described in the Operating Instructions.**

## 2.5.4 Commissioning staff

The commissioning employee is a qualified, skilled authorized person.

The commissioning employee

- Commissions the Servo Control System.
- switches the line disconnecter on and off
- enters the password for the user level 2 (Level 2) (Process observance),
- selects the operating modes
  - Setup
  - Reference run
  - Manual mode
  - Automatic mode
- switches the drives on and off
- moves the servo drives into manual mode
- controls the proper operation of the drive
- carries out corrections on the program sequence if needed
- generates a commissioning log and releases the machine.

	<b>DANGER!</b>	<p><b>Mechanical danger</b></p> <p><b>During the commissioning of the Servo Control System, not all protective equipment is possibly active!</b></p> <p><b>Non-compliance can result in death or serious injury through mechanical danger.</b></p>
<ul style="list-style-type: none"> <li>• The commissioning may only be done by qualified, knowledgeable skilled workers!</li> <li>• Make sure that no people are located in the immediate surroundings of the servo drive.</li> <li>• Make sure that no objects or tools are located in the immediate surroundings of the servo drive.</li> <li>• Check the operating parameters (speed, torque, acceleration, delay) set on the controller prior to commissioning</li> <li>• Carry out all program steps with at most 10% of the maximum torque.</li> <li>• Wear suitable personal protective gear (safety goggles, safety shoes, helmet, protective clothing)</li> </ul>		

The installation and commissioning is done by specialists skilled staff and is not covered in the Operating Instructions.

## 2.5.5 Assembly and maintenance staff

The assembly and repair staff consists of qualified, knowledgeable skilled workers, electricians, mechanics.

The assembly and maintenance staff

- χαρρρισ ουτ τηε ασσαμβλυσ οφ τηε μεχηανιχαλ ανδ ελεχτριχαλ χομπονεντς οφ τηε Servo Control System.s
- maintains the mechanical and electrical components of the Servo Control System.
- carries out the service work and repairs.
- carries out the troubleshooting and elimination.
- cleans the Servo Control System.
- carries out the inner cleaning on the Servo Control System.

	<b>WARNING!</b>	<b>Assembly and maintenance work</b> <b>The consequences of improper service and maintenance may result in loss of life, personal injuries, material damage or environmental impairments.</b>
<ul style="list-style-type: none"> <li>• The assembly and maintenance work may only be done by qualified, knowledgeable skilled workers!</li> <li>• Switch off the Servo Control System at the line disconnecter (main switch) and secure it to prevent restarting!</li> <li>• Immediately mount all protective guards and safety devices and check their function upon completion of maintenance and service work!</li> </ul>		

	<b>WARNING!</b>	<b>Troubleshooting and error elimination</b> <b>The consequences of improper troubleshooting and error elimination and maintenance may result in loss of life, serious or minor personal injuries, material damage or environmental impairments.</b>
<ul style="list-style-type: none"> <li>• The troubleshooting and error elimination may only be done by qualified, knowledgeable skilled workers.</li> </ul>		

	<b>NOTICE!</b>	<b>Spare parts</b> <b>The consequences of using unsuitable spare parts could be damage to property.</b>
<ul style="list-style-type: none"> <li>• Spare parts must meet the technical requirements of the machine manufacturer!</li> <li>• Only use original spare parts from the manufacturer!</li> </ul>		

The assembly and maintenance is done by specialists skilled staff and is not covered in the Operating Instructions.

## 2.6 Handling

In this chapter, you will receive information on transporting, receiving and storing the Servo Control System .

### 2.6.1 Transport

	<b>WARNING!</b>	<b>Transport</b> <b>Parts which drop can result in death or serious injuries.</b>
<ul style="list-style-type: none"> <li>• Observe the weight!</li> </ul>		

The Servo Control System is delivered in transport boxes.

The accessories, (motor cable, signal cable, interface cable, commissioning box) are delivered in transport boxes.

The design of the transport packaging depends on the contractual regulations and the destination location.

Components	Mass approx. /kg
Servo Control System SKS-4.1	21
Accessories	7

Table 4 Mass table SKS-4.1

Components	Mass approx. /kg
Servo Control System SKS-4.2	22.5
Accessories	9.5

Table 5 Mass table SKS-4.2

Components	Mass approx. /kg
Servo Control System SKS-4.3	25
Accessories	12

Table 6 Mass table SKS-4.3

## 2.7 Disposal

	<b>NOTICE!</b>	<p>Improper disposal Improper disposal can damage the environment.</p>
<ul style="list-style-type: none"> <li>Dispose of the Servo Control System properly or use a company which specializes in this type of disposal!</li> </ul>		

## 2.8 Emergency, extinguishing materials

In case of an emergency, switch the Servo Control System off immediately on the mains switch!

If the Servo Control System catches fire, extinguish it with ABC powder or with carbon dioxide.

If you extinguish with water, observe the necessary minimum safety distance!

The minimum safety distance is dependent on the nozzle diameter, sprayjet or solid jet.

When using a C pipe with a nozzle (12 mm) and sprayjet, the minimum safety distance is one meter.

With a solid jet, the minimum safety distance is five meters.

# Chapter

# 3

### 3 Machine description

In the following, you will receive a basic description of the Servo Control System<b2/>.

Depending on the modality, the full number of connection ports may not be installed which deviates from the illustrations.

Also the displayed connection ports can vary as an option.

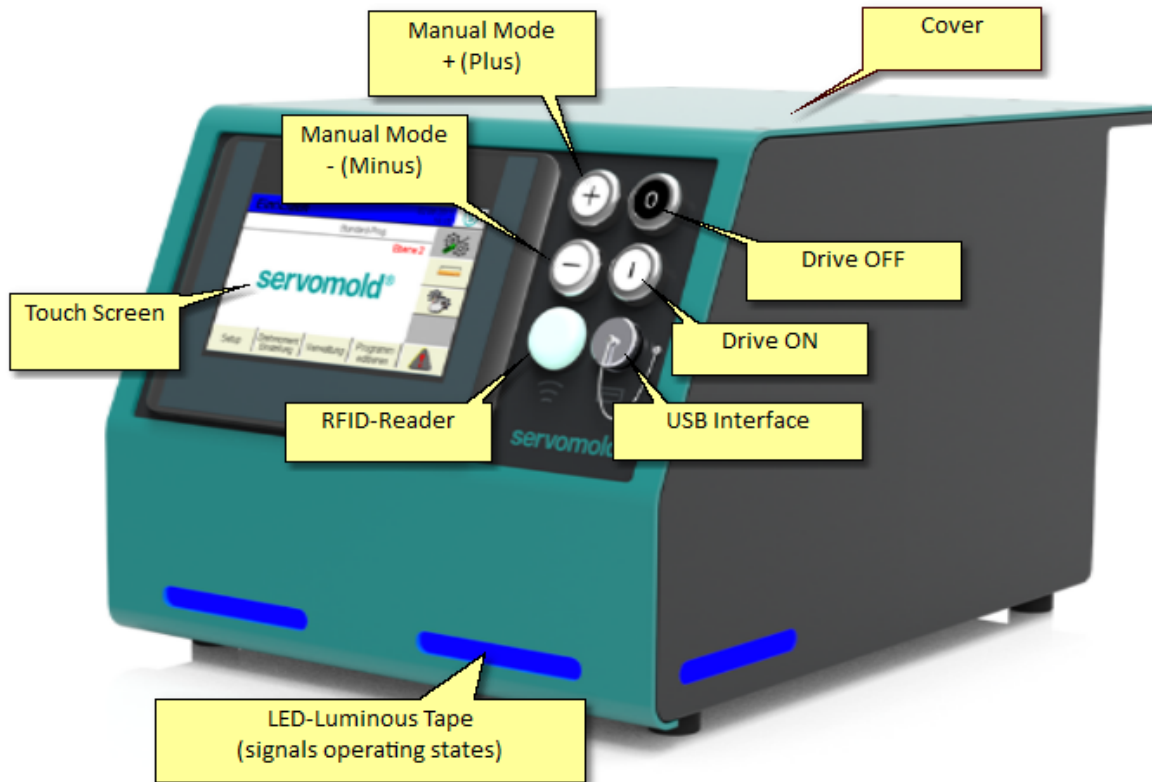

Fig. 5 View Control panel Servo Control System with control panel



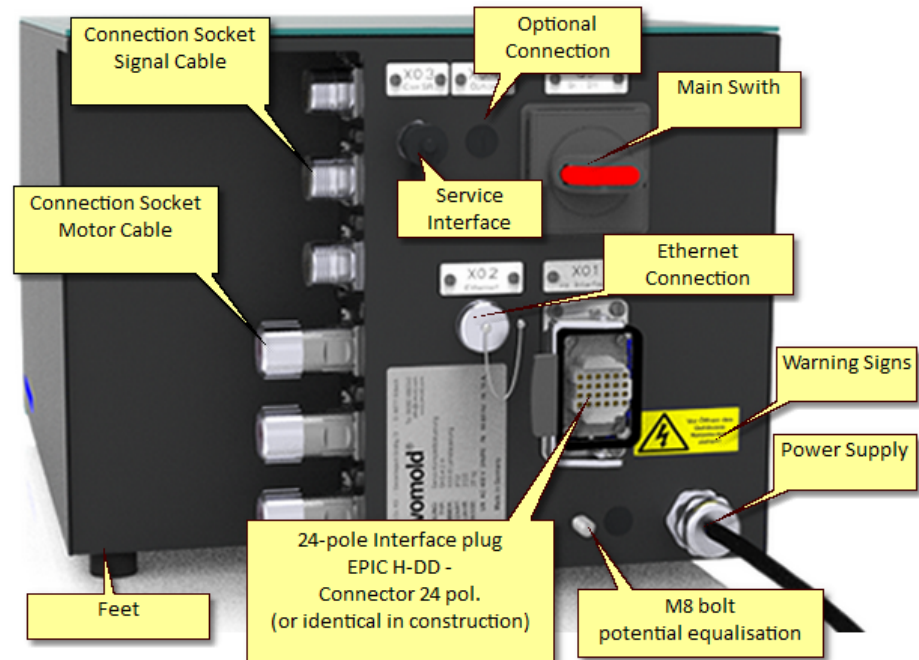

Fig. 6 Rear view Controller Servo Control System

**Service interface, Ethernet interface and optional connections are only required for the commissioning and is not covered in these Operating Instructions.**

### 3.1 Function

The Servo Control System is exclusively designed and produced for the control of

- Servo unscrewing units "Single" (SAE), "Double" (SAD) and "Quad" (SAV)
- Servo multi-drives (SMA) for operating the servo unscrewing unit "Multi" (SAM)
- Servo drive unit "Gear wheel" (SAZ) and servo drive unit "Shaft" (SAW)
- Servo angle drive "Gear wheel" (SWZ) and servo angle drive "Shaft" (SWW)
- Servo linear drives "Screw drive" (SLG)
- Servo screw drive "Single" (SSE) and "Double" (SSD)
- Servo drives by Servomold GmbH & Co.KG on tools for injection molding machines
- Servo drives by Servomold GmbH & Co.KG within the safe zone of a machine
- Servo drives released by Servomold GmbH & Co.KG on tools for injection molding machines or within the safe zone of a machine

### 3.2 Electrical connections

The electrical connection as well as the motor connection may only be installed by qualified electricians and is not covered in these Operating Instructions.

### 3.3 USB interface

Only authorized people (Main setter, commissioning staff) may use the USB interface for the administration of programs, therefore this is not covered in these Operating Instructions.

# Chapter

# 4

## 4 Operation

In this chapter, you will receive information on the operation of Servo Control System. The functions described here can be carried out in the user level 4.

All functions above and beyond these such as, e.g. the movement of the drive into the jog mode or the editing of programs, require the switching on of the user levels 2 or 3 and are not covered in the Operating Instructions.

Observe the specified safety instructions in the chapter [Safety](#)<sup>10</sup> as well as the information on [authorized operating personnel](#)<sup>16</sup>, [Safety equipment](#)<sup>13</sup> and [workplaces](#)<sup>14</sup>.

Make sure that only the suitable program is loaded that is associated with the respective tool!

	<b>NOTICE!</b>	<p><b>False machine parameter</b></p> <p><b>Through erroneously adjusted machine parameters, property damage on the Servo Control System or on the injection mold can occur.</b></p>
<ul style="list-style-type: none"> <li>• The setting of the machine parameter and the commissioning may only be carried out by a qualified technician!</li> <li>• Observe the information on maximum speed / max. torque of the drive/transmission combination used!</li> <li>• Only set the machine parameters using the assembly and operating instructions provided by the manufacturer of the drive/transmission combination!</li> <li>• Make sure that only the program is loaded that is associated with the respective injection mold!</li> </ul>		

### 4.1 Main operating modes

The main operating modes are set in the right menu bar - depending on the status of the controller and user level, the access to the operating modes is only possible to a limited extent - thus, e.g. the selection of the operating mode "Automatic" is not possible with a non-homed drive.

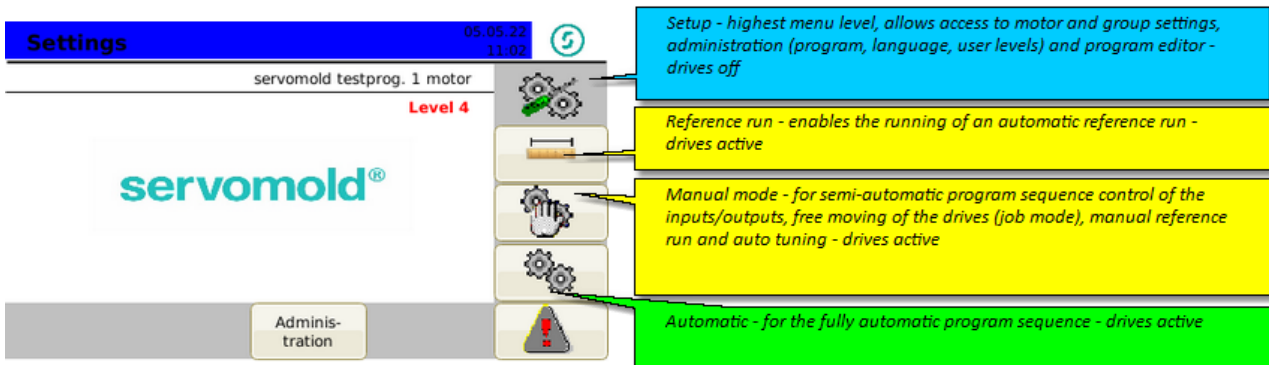

Fig. 7 Operating modes

Operation

Depending on the operating mode, the operating statuses of the Servo Control System is displayed by various colors and a static or blinking status line or illuminated LED strip:

Color	Operating mode	Operating status - LED blinking	Operating status - LED static
blue	Setup	Booting of the controller	Relays active - Normal status
yellow	Reference / Manual operation	Drive OFF (inactive) or Notice of fault (in all operating modes)	Drive active - Normal status
green	Automatic mode	Automatic Off	Drive active - Normal status
red	Fault	Drive inactive or notice of fault or error (in all operating modes)	not available

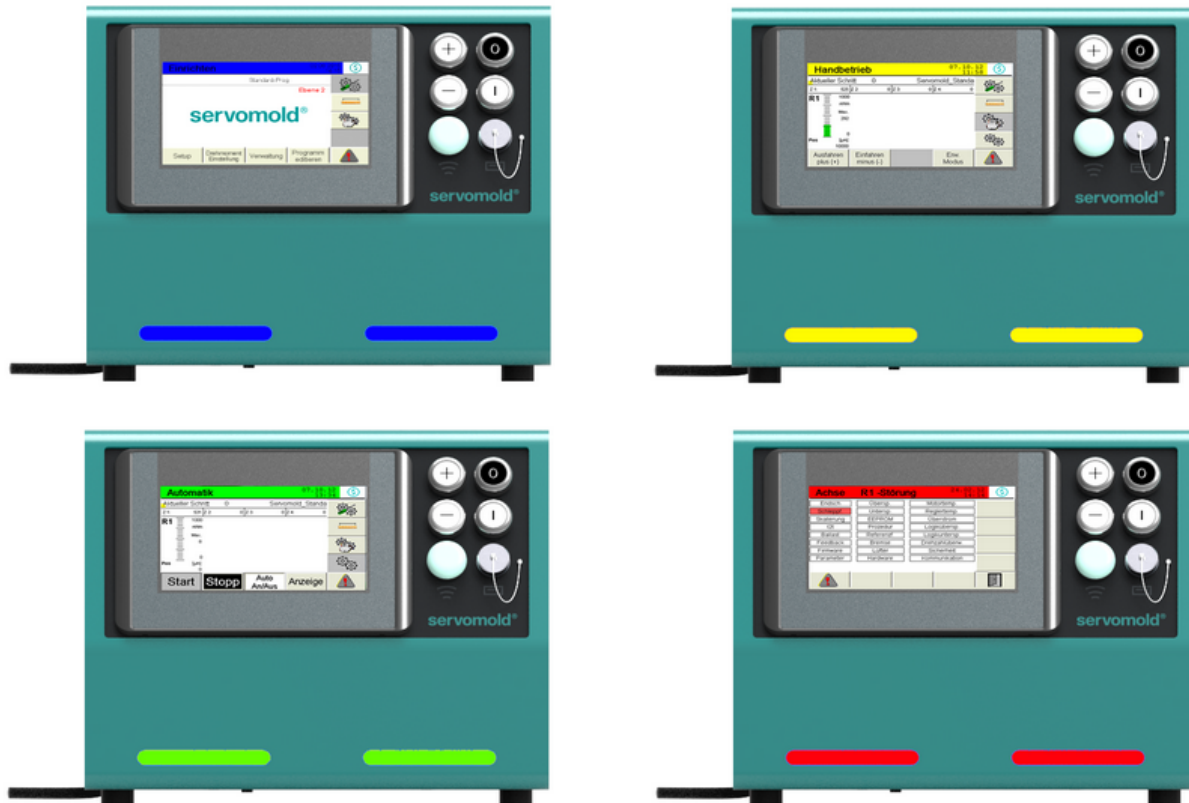

Fig. 8 Operating modes - Illuminated LED strip

## 4.2 Switch on and login

When the Servo Control System is switched on at the main switch, the controller is started. The boot process takes approx. 1 minute - afterwards the following start screen appears and no user level is active

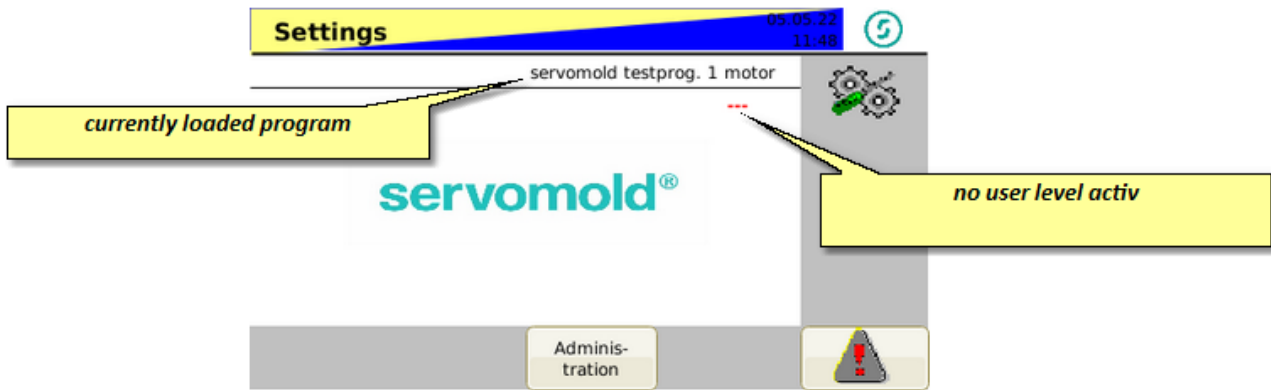

Fig. 9 Start screen

To be able to operate the Servo Control System, log in with user level 4 (operator-key / green RFID-Transponder) or with user level 2 (master-key / red RFID-Transponder). To log in, use the respective RFID-Transponder



Bild 10 Servo Control System with RFID-Reader



Bild 11 RFID-Transponder ret + green

In the following example, user level 4 is active and allows only limited access to the functions of the controller.

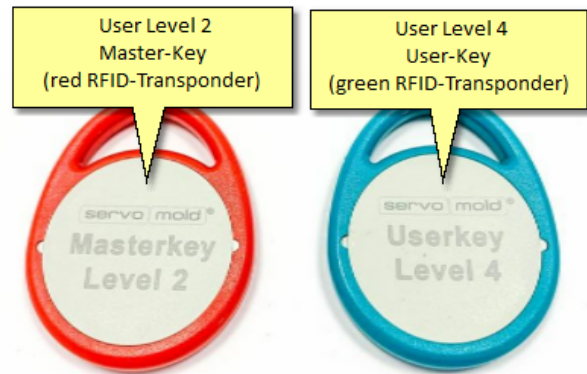
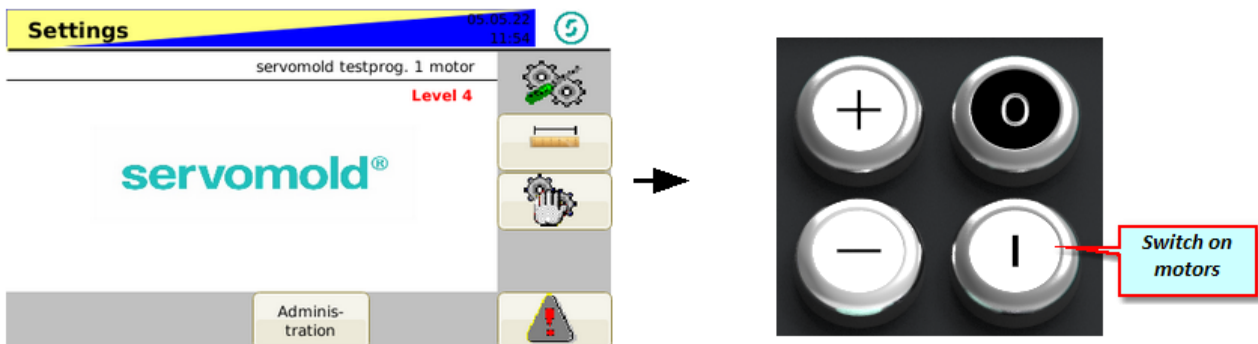

Fig. 12 User level 4 - drive inactive

The yellow/blue flashing of the upper bar indicates that the drive is not active yet. Another indication of inactive drives is the flashing LED light strip at the front side of the device.

## Operation

As soon as the drive is switched on (safety relay activated), the display changes to blue static.

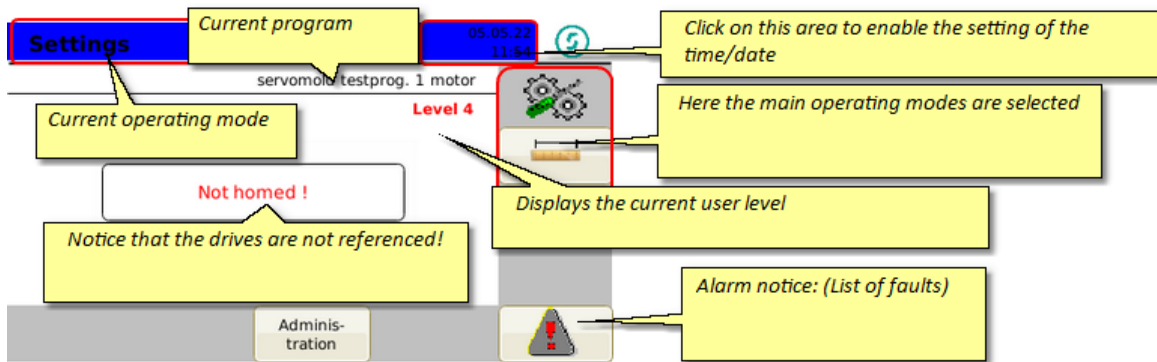

Fig. 13 User level 4 - drive active

### 4.3 Loading program

When switching on the controller, the last valid program is always loaded - if changes have been made to the program parameters, these are loaded also. If these changes have not been saved, they will be lost when you load a program.

If the right program is not loaded, load the program associated with the injection mold in the controller.

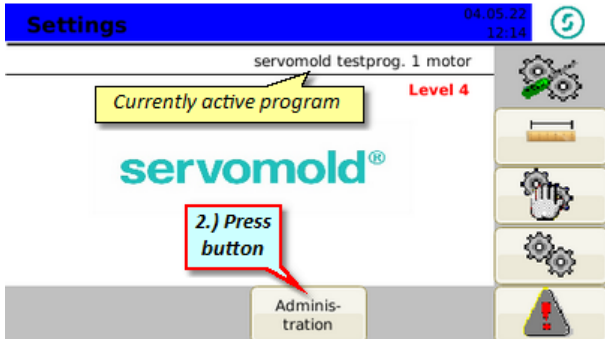

Fig. 14 Setup - Administration

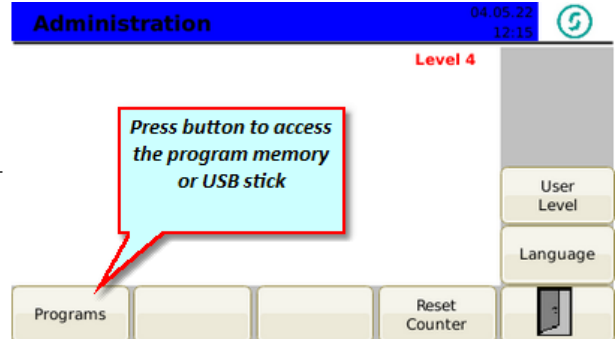

Fig. 15 Administration

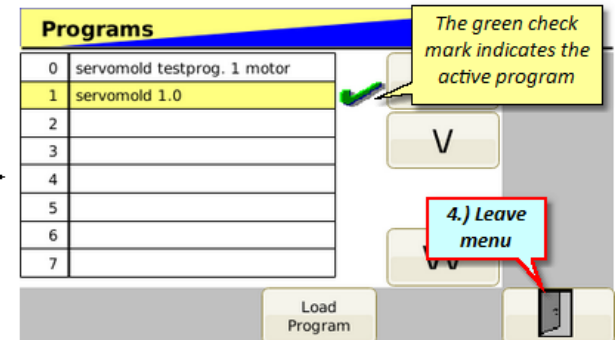
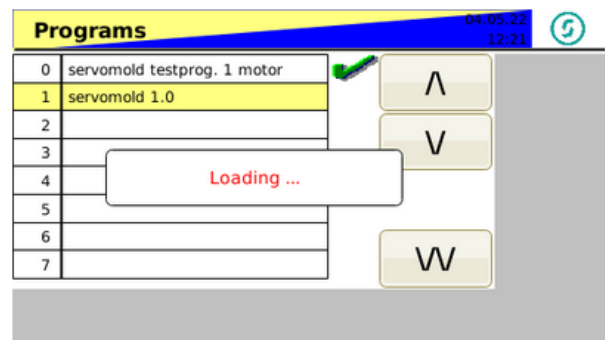
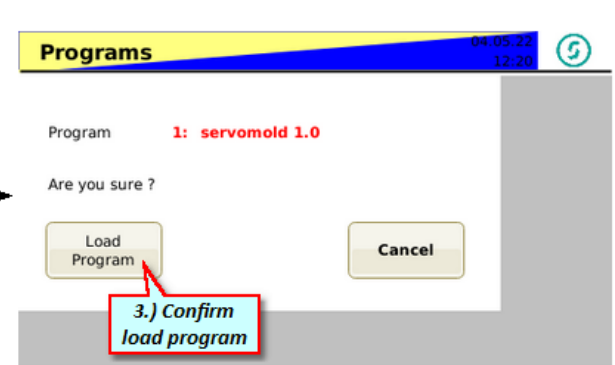
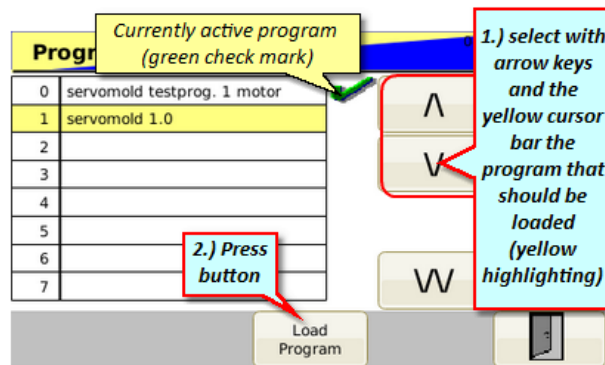



Fig. 16 Load program



## 4.4 Homing

Since the homing requires keeping a certain order during the homing under special circumstances, the homing is defined as a subroutine in the program sequence.

The homing can be initiated at any time by the setter. This is (depending on the motor-position sensor system used) required at the restart of the controller or when the setter thinks this is necessary for renewed homing.

	<b>NOTICE!</b>	<p><b>Wrong initial position of the injection mold prior to the homing</b></p> <p>Through the wrong initial position of the injection mold prior to the homing, the injection mold could be damaged.</p>
<ul style="list-style-type: none"> <li>The initial position prior to the homing is to be set individually and on the respective injection mold by the commissioning staff..</li> <li>Check that the initial position is set prior to the homing.</li> </ul>		

In the following, the start of the homing is explained.

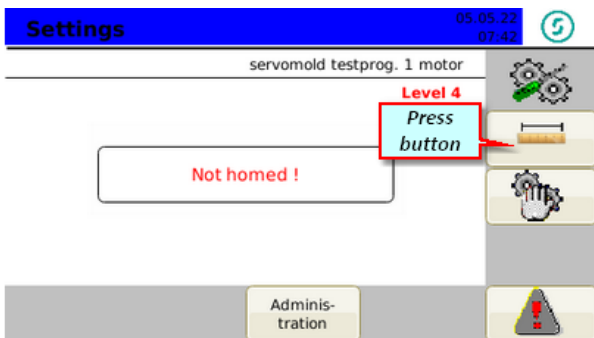

Fig. 17 Setup - Homing

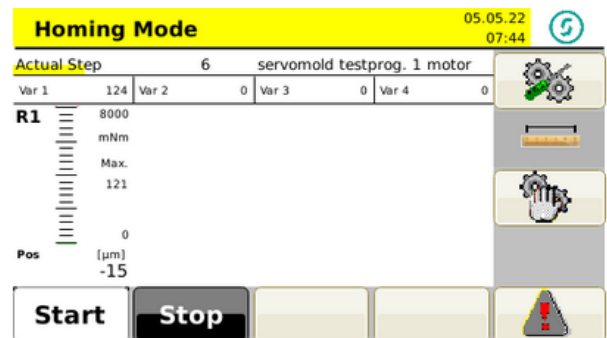

Fig. 18 Homing

Fig. 19 Start homing

## 4.5 Manual mode

After referencing, the manual mode enables a simple method to check the movement of the motors. The program (previously defined in the program editor) is executed - manual mode simulates the setting of the input signals by the injection molding machine by pressing the button "Move out (Jog +)" or "Move in (Jog -)".

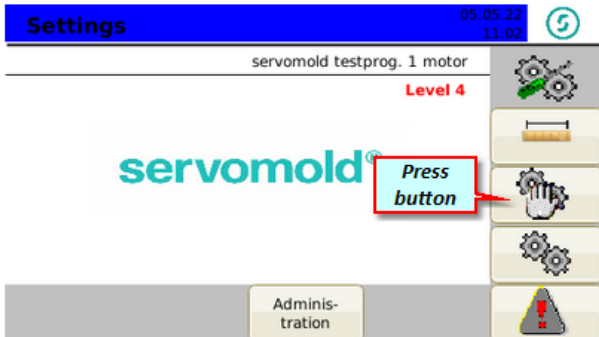

Fig. 20 Setup - Manual mode

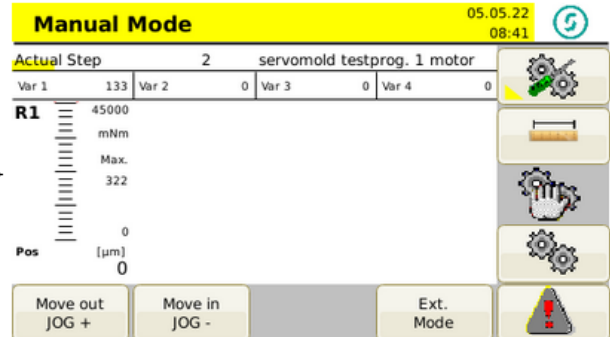

Fig. 21 Manual mode

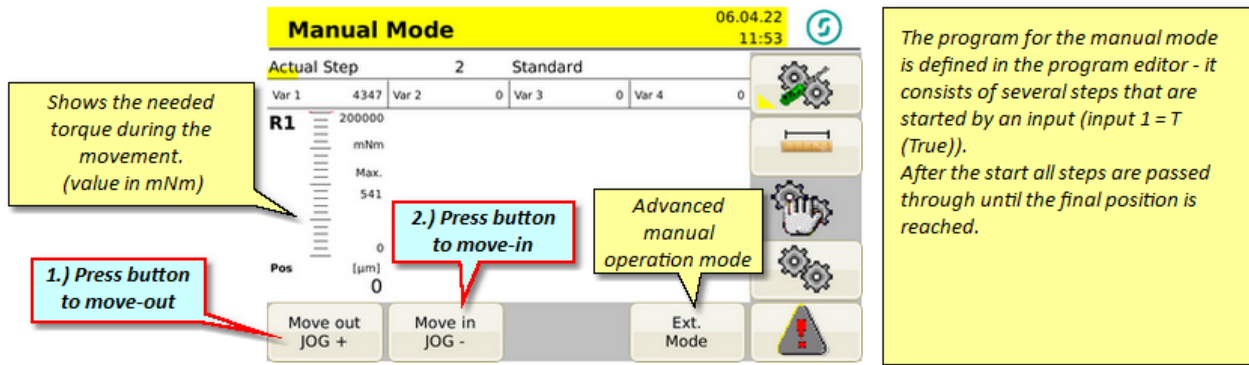

Fig. 22 Manual mode - Turn in / Turn out

In the manual mode too, the controller responds to signals from the injection molding machine - thus a fully automatic process can also be carried out in the highest manual mode level.

## 4.6 Automatic mode

When changing into the automatic mode, the controller waits for the signal to start the program sequence set in the program. If you change to the automatic mode, the button "Setup mode" and "Reference run" are faded out to prevent an unintended interruption of the program sequence. In order to get to the setup mode, you must first change to the manual mode.

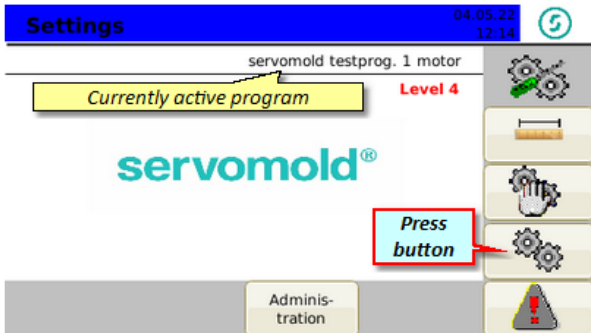

Fig. 23 Setup - Automatic

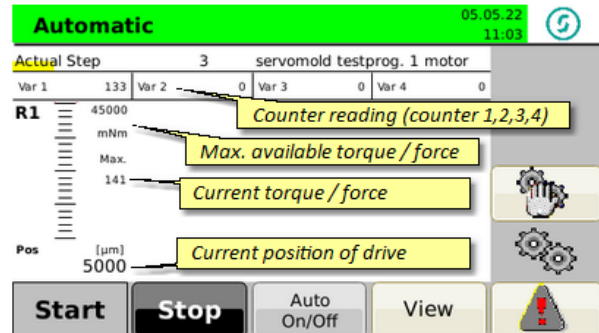

Fig. 24 Automatic

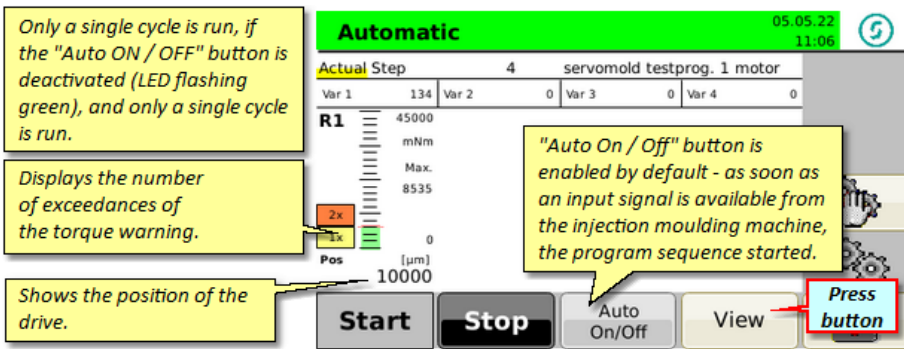

Fig. 25 Automatic Auto On/Off

If the "Auto On / Off" button is deactivated, then the program is still being processing and will automatically stop.

By the pressing the "Stop" button, the program sequence stops immediately.

By pressing the "Start" button, the control is ready and waiting for the incoming signal.

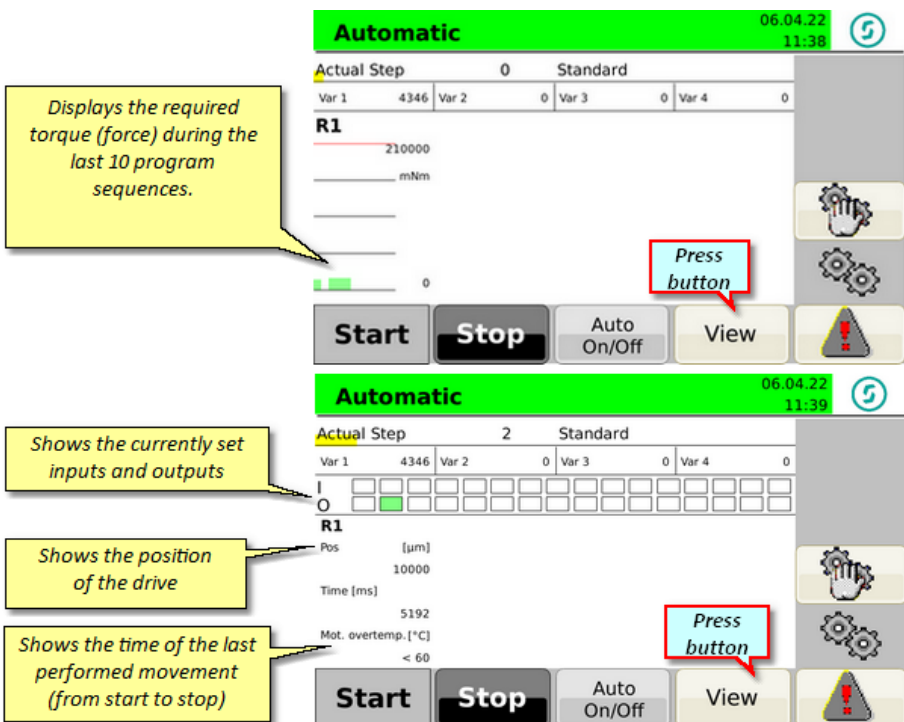

Fig. 26 Automatic - Display

Pressing the "Display" button will change the display type:

- individual torque is shown...

or

- torque of the last 10 cycles is shown....

or

- Information screen (input, output, position, time) is shown.

## 4.7 Switching off

To switch off the controller, wait until the current cycle on the injection molding machine is finished or deactivate the "Auto On/Off" button and wait until the current cycle is finished. Check to see if the established initial position has been set by the commissioning staff.

	<b>NOTICE!</b>	<p><b>Wrong initial position when switching off</b></p> <p>Through a wrong initial position, the injection mold machine could damage the injection mold when switching off.</p>
<ul style="list-style-type: none"> <li>The initial position prior to the switching off is to be set individually and on the respective injection mold by the commissioning staff.</li> <li>Make sure that prior to the switching off of the controller, the initial position has been set.</li> </ul>		

Switch into the manual mode and then into the setup mode. After you have switched the drives off, you can turn the line disconnecter to off.

	<b>NOTICE!</b>	<p><b>Switching off</b></p> <p>The consequences of switching off in the active status of the controller can be damage to the servo controller.</p>
<ul style="list-style-type: none"> <li>Change into the setup mode prior to the switching off of the controller.</li> <li>Switch the servo controller off prior to the switching off of the controller (0 button).</li> </ul>		

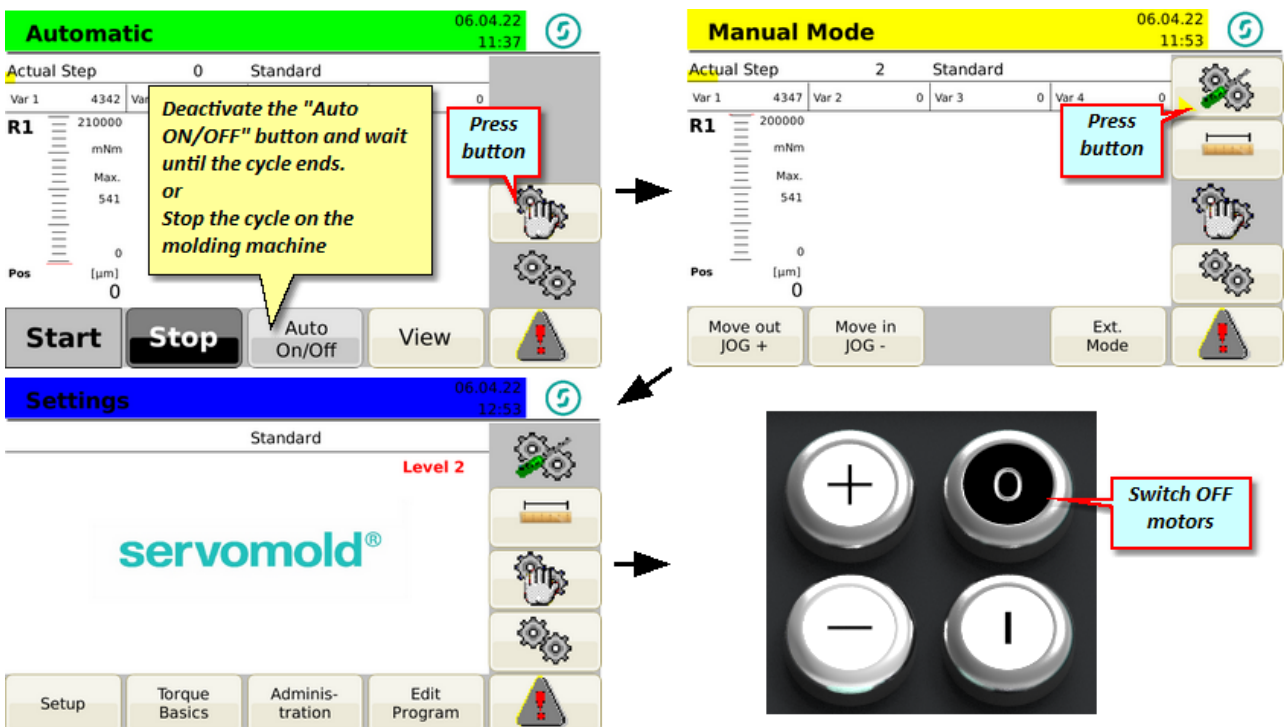

Fig. 27 Stop automatic

# Chapter

# 5

## 5 Faults

Faults can occur during the daily operations. All work above and beyond the elimination of faults such as maintenance and/or service work may only be done by qualified, knowledgeable skilled workers and is not covered in these Operating Instructions.

	<b>WARNING!</b>	<p><b>Danger through non-secured shutdown machine</b>  <b>The operator can be seriously injured on a non-secured shutdown Servo Control System.</b></p>
<ul style="list-style-type: none"> <li>• With the fault elimination, securely shut down the Servo Control System by switching off the drive!</li> <li>• The maintenance work may only be done by qualified, knowledgeable skilled workers!</li> <li>• Repairs and error elimination work may only be done by Servomold GmbH &amp; Co.KG or by qualified, knowledgeable skilled workers.</li> <li>• Observe the warnings and safety instructions!</li> </ul>		

### 5.1 Types of faults

Basically, a distinction is made between faults or errors in the area of **hardware** (faults in the servo controller or faults in the controller hardware) and **software** (faults through the exceeding of the monitoring limits)

	<b>INFO</b>	<p><b>Faults in the servo controller (drive)</b>  <b>These faults include, e.g. i<sup>2t</sup>, tracking errors, undervoltage, overvoltage, etc. - in addition to acknowledging the fault message, the fault must be reset in the servo controller (drive)!</b></p>
<ul style="list-style-type: none"> <li>• The fault in the servo controller (drive) is displayed in the alarm menu on the left menu button with a red triangle.</li> <li>• When changing into the fault menu, details on the fault are displayed and can be reset with the corresponding authorization.</li> <li>• Then the fault message must be acknowledged.</li> </ul>		

In many cases, faults are, however, not caused by a malfunction of the controller but only by incorrect settings of the operating parameters.

The faults are displayed with differing priorities and status messages depending on the priority and type of fault. The following table shows only a part of the possible faults - if you have questions on this, please contact the manufacturer Servomold GmbH & Co.KG

## Faults

Priority	Fault message	Error Type	Error detail	Measures	Elimination by
0	Axis 1 error	Hardware	<ul style="list-style-type: none"> <li>• <math>i_{\text{t}}</math> (rated current permanently exceeded)</li> <li>• Tracking error</li> <li>• Overvoltage</li> </ul>	<ul style="list-style-type: none"> <li>• Maintain mechanics (ease of motion) - check torque requirement during idling(</li> <li>• Check speeds and accelerations - check tracking error limit in setup</li> <li>• Setup - Check motor setup - correct motor selection if needed</li> </ul>	Main setter or Commissioning Staff
0	Axis 1 error	Hardware	<ul style="list-style-type: none"> <li>• Motor temperature</li> <li>• Feedback + motor temperature</li> </ul>	<ul style="list-style-type: none"> <li>• Measure temperature on motor - Maximum temperature of 130°C may not be exceeded</li> <li>• Check seat and arrangement of motor and signal cable</li> </ul>	Electrician
1	Axis 1 error limit torque moment	Software	The limit torque set in Setup - Group - Torque settings (Max. torque) has been exceeded.	<ul style="list-style-type: none"> <li>• Check mechanics for damages and/or contamination</li> <li>• Check torque limit and correct if needed.</li> </ul>	Main setter or Commissioning Staff
2	Current limit exceeded repeatedly	Software	The warning limit (torque/force warning) set in Setup - Group - Torque settings has been exceeded at least 3x.	<ul style="list-style-type: none"> <li>• Check mechanics for damages and/or contamination</li> <li>• Check torque limit and correct if needed.</li> </ul>	Main setter or Commissioning Staff
8	Axis 1 error in the initialization	Hardware	<ul style="list-style-type: none"> <li>• Undervoltage</li> </ul>	<ul style="list-style-type: none"> <li>• Check motor protection switch check seat of power connector switch X10 on controller underside.</li> </ul> <p>Contact, if needed the manufacturer Servomold GmbH &amp; Co.KG to coordinate other measures.</p>	Electrician
9	Axis 1 Warning current limit	Software	The warning limit (torque/force warning) set in Setup - Group - Torque settings has been exceeded.	<ul style="list-style-type: none"> <li>• Check mechanics for damages and/or contamination</li> <li>• Check torque limit and correct if needed.</li> </ul>	Main setter or Commissioning Staff
	Without message: Protective door open	External Fault	The protective doors were opened after the cycle end or during the operation - the safety relay in the controller has been activated.	<ul style="list-style-type: none"> <li>• Close the protective doors and activate the controller by pressing the button (1) on the control panel</li> </ul>	setter

Table 7 Faults on the Servo Control System

Condition	Importance	Explanation
Into	Error is still pending	An example is an error in the initialization - the error is still pending and cannot be eliminated even by acknowledging.
Outof	Error no longer pending	An example is the exceeding of the limit torque - the error is detected and reported; is no longer pending.
Ack	Error still pending, but is already acknowledged.	An example is a hardware "tracking error" which has already been acknowledged in the alarm menu but has not yet been reset in the controller.

Table 8 Error statuses of the Servo Control System

Faults in the drive (e.g. tracking error) can be represented in the alarm menu under the menu item Fault Details. The reset requires a change to the operator level 3 and may only be done by the Main setter and/or the commissioning staff. The reset of the axis fault requires the subsequent acknowledgment of the fault in the alarm menu.

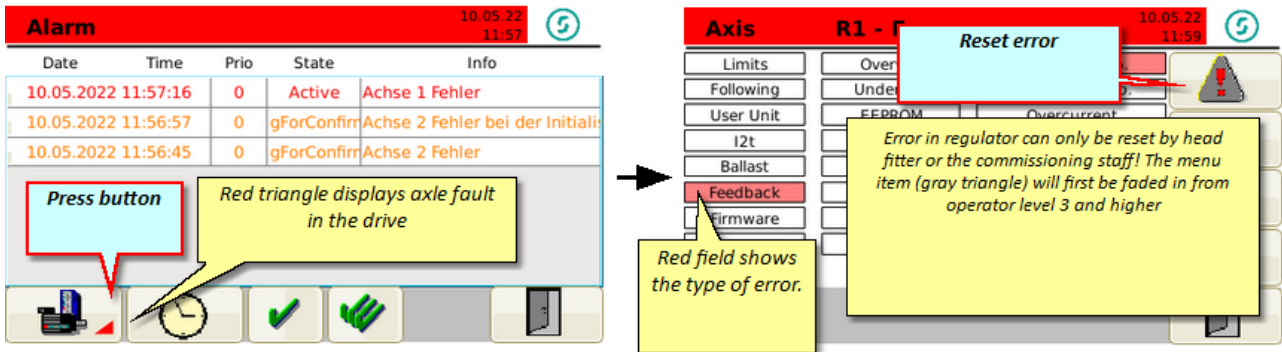

Fig. 28 Fault in servo controller (drive)

In addition to the faults listed in the fault table, there are also situations which do not result in a fault message but which impact the function of the system disadvantageously.

A "maximum torque" which is set too low for the homing of the drives stop before reaching the actual home position and assume a false position. Here, it should be observed during commissioning that the torque limit for the homing is not set too low.

## 5.2 Reset faults

All faults which occur during the operation of the Servo Control System caused by the servo drive or the force monitoring of the software, must be acknowledged in the alarm menu to continue the program. The faults are displayed with differing priorities and status messages depending on the priority and type of fault.

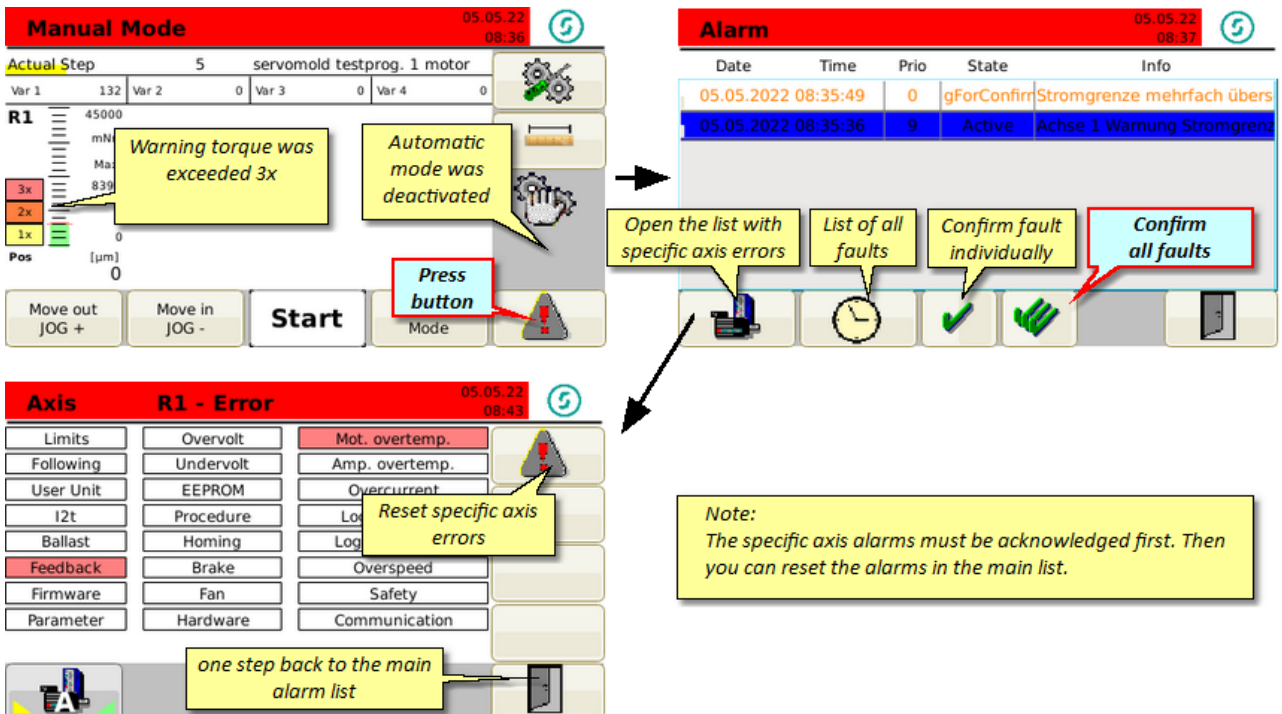

Fig. 29 Alarm menu

The fault list shows the exact time of the fault and gives a description of the fault.



Faults

After the fault has been acknowledged and the error has been eliminated, the drive is first moved in the manual mode (extend/retract). Here, the setter should check to see if the mechanics are working without a problem before he operates the system in automatic mode again.

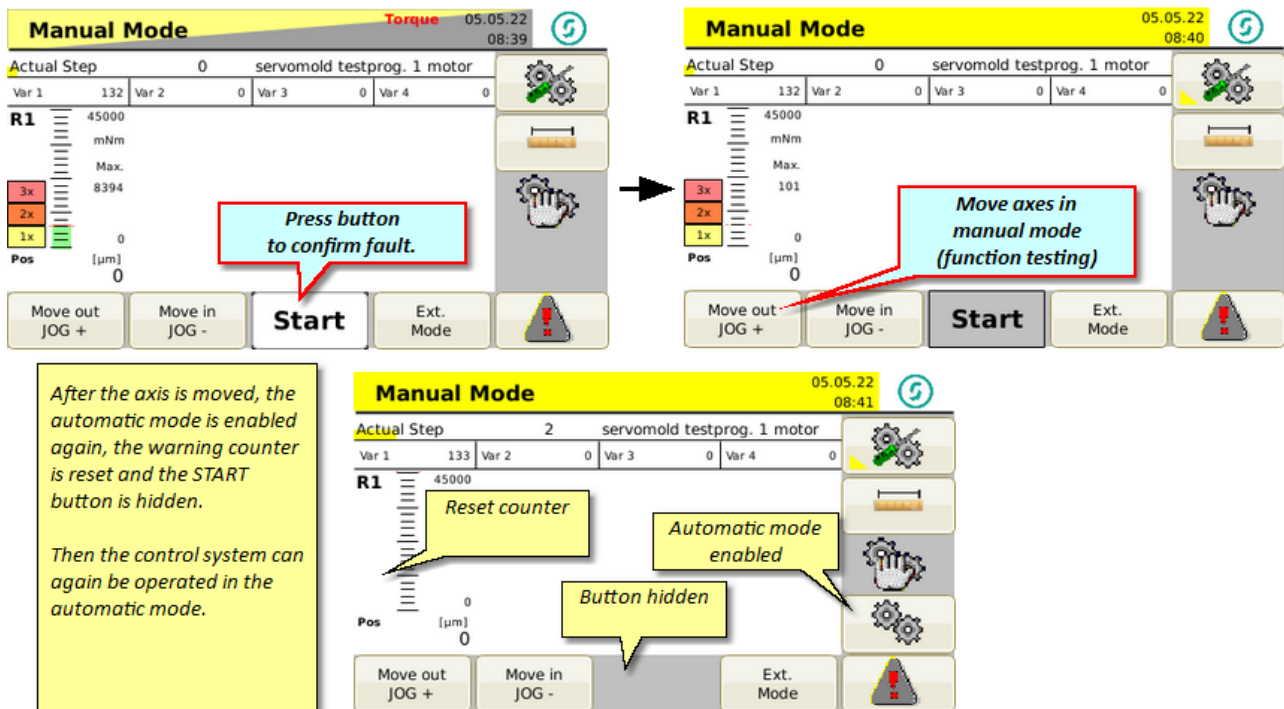

Fig. 30 Reset fault

# Chapter

# 6

## 6 Maintenance

	<b>WARNING!</b>	<b>Maintenance work</b> <b>Improper service and maintenance may result in loss of life, personal injuries, material damage or environmental impairments.</b>
<ul style="list-style-type: none"> <li>• The maintenance work may only be done by qualified, knowledgeable skilled workers.</li> <li>• Turn off the control at the line disconnecter (main switch) and secure with a lock to prevent restarting!</li> <li>• Immediately mount all protective guards and safety devices and check their function upon completion of repair work!</li> </ul>		
	<b>NOTICE!</b>	<b>Spare parts</b> <b>The consequences of using unsuitable spare parts could be damage to property.</b>
<ul style="list-style-type: none"> <li>• Spare parts must meet the technical requirements of the machine manufacturer!</li> <li>• Only use original spare parts from the manufacturer!</li> </ul>		
	<b>NOTICE!</b>	<b>Improper cleaning</b> <b>Functions can be impaired through improper cleaning of the Servo Control System.</b>
<ul style="list-style-type: none"> <li>• Never clean with steam or water jet spray!</li> <li>• Do not use flammable, easily gasified or corrosive liquids to clean!</li> </ul>		
	<b>NOTICE!</b>	<b>Erroneous adjustment, worn or defective components</b> <b>Erroneous adjustment, worn or defective components can impair the functions of the Servo Control System, as well as cause damage to the Servo Control System or the injection mold.</b>
<ul style="list-style-type: none"> <li>• Allow regular maintenance work to be performed by a skilled person!</li> </ul>		

The Servo Control System should be cleaned annually by an electrician.

Because dust can penetrate through the ventilation openings, the machine should be blown out with compressed air once a year.

### 6.1 Maintenance plan

A longer service life and process reliability can be expected with thorough maintenance and care of the Servo Control System.

WHAT?	WHEN	HOW	WHO
Display (Touchscreen)	Weekly	<ul style="list-style-type: none"> <li>• Switch off device</li> <li>• Wipe screen and device free with suitable cleaning agent</li> <li>• Do not spray the cleaning agent directly onto the screen or the device front but onto the cleaning cloth.</li> </ul>	People authorized by the operator
Motor, signal and interface lines	Daily, before use	<ul style="list-style-type: none"> <li>• Check cables, lines visually for damage</li> <li>• Identify and eliminate unfavorable laying of cables/lines</li> <li>• Inform electrician if damage is detected in the lines.</li> </ul>	Operator
Servo Control System	Annually	<ul style="list-style-type: none"> <li>• Switch off device</li> <li>• Open housing and clean inside</li> <li>• Blow out device with compressed air</li> <li>• Close housing and replace sealing strip if needed</li> </ul>	Electrician

Table 9 Maintenance plan for Servo Control System

## 6.2 Error list

Repairs, troubleshooting and elimination may only be done by authorized and qualified skilled workers.

Error	Error description	Possible causes	Error elimination
Electrical error (Customer-side)	Automatic circuit breaker triggered customer-side	<ul style="list-style-type: none"> <li>Damaged lines (insulation)</li> <li>Cable break (line or cable severed)</li> <li>Electrical components defective (e.g. plug defective)</li> </ul>	only by electrician: <ul style="list-style-type: none"> <li>Eliminate causes</li> <li>Replace defective components</li> </ul>
Electrical error (device-side)	axis reports error in the initialization (undervoltage)	<ul style="list-style-type: none"> <li>Motor protection switch triggered</li> </ul>	only by electrician: <ul style="list-style-type: none"> <li>Eliminate causes (overcurrent or failure of a phase)</li> <li>Switch motor protection switch (in housing) back on</li> </ul>
Electrical error (device-side)	Safety relay triggered - illuminated LED strip signals a fault by yellow blinking	<ul style="list-style-type: none"> <li>Self-reset fuse on the control PCB has triggered - This can be due to, e.g. a short circuit on the interface connector (e.g. 24V to ground)</li> </ul>	only by electrician: <ul style="list-style-type: none"> <li>Eliminate causes (eliminate short circuit)</li> <li>Disconnect device at main switch and wait 10 sec.</li> <li>Switch on device again at main switch.</li> </ul>
Mechanical error	Housing greatly damaged	<ul style="list-style-type: none"> <li>Transport damage or damage during handling</li> </ul>	only by electrician: <ul style="list-style-type: none"> <li>Inspect damage, if necessary eliminate/repair - contact Servomold GmbH &amp; Co.KG in any case.</li> </ul>
Mechanical error	General damage to the Servo Control System	<ul style="list-style-type: none"> <li>Transport damage or damage during handling</li> </ul>	only by electrician: <ul style="list-style-type: none"> <li>Inspect damage, contact Servomold GmbH &amp; Co.KG in any case.</li> </ul>
Display error (touchscreen)	Screen remains dark after start-up	<ul style="list-style-type: none"> <li>Voltage supply not specified</li> </ul>	only by electrician: <ul style="list-style-type: none"> <li>Inspect damage, if necessary eliminate/repair - contact Servomold GmbH &amp; Co.KG in any case.</li> </ul>
Display error (touchscreen)	Date/time is not correct	<ul style="list-style-type: none"> <li>Device is without current for longer than a week</li> </ul>	by authorized person: <ul style="list-style-type: none"> <li>Reset time at system level.</li> </ul>
Display error (touchscreen)	Application software does not start. (Screen remains blue)		<ul style="list-style-type: none"> <li>Disconnect device at main switch and wait 10 sec.</li> <li>Switch on device again at main switch.</li> </ul>
Electrical error (device-side)	After switching on the mains switch the control does not start.	Main fuse triggered	only by electrician <ul style="list-style-type: none"> <li>Replace main fuse (2.5 A)</li> </ul>

Table 10 Error list for Servo Control System

# Chapter

# 7

## 7 Spare parts

Item	Item number	Description	Manufacturer
Motor cable	SMK-05 Speedtec	Motor cable, 5m length, shielded, plug on both sides - male / female	<b>Servomold GmbH &amp; Co.KG</b>
Signal cable	SGK-05 Speedtec	Signal cable, 5m length, shielded, double-sided plug	Signal cable, 5m length, shielded, double-sided plug
Interface cable	SSK-05-dd24-oe	Interface cable, 5m length, plug DD24, shielded oil flex, open cable end	<b>Servomold GmbH &amp; Co.KG</b>
Interface cable	SSK-05-dd24-24b	Interface cable, 5m length, plug DD24/24B, shielded oil flex	<b>Servomold GmbH &amp; Co.KG</b>
Touchpen	touch pen	Touchpen, incl. holder	<b>Servomold GmbH &amp; Co.KG</b>
Countersunk screw		Counter sunk screw M4x8 with cross head, DIN 965	<b>Servomold GmbH &amp; Co.KG</b>

Table 11 Spare parts list for Servo Control System

# Index

## - A -

Ambient conditions 11  
Automatic mode 35

## - C -

Changing the location 7  
Commissioning staff 20

## - D -

Disclaimer 8  
Disposal 22

## - E -

Emergency 22  
Emergency Stop Device 14  
Emission sound pressure level 12  
Extinguishing agents 22

## - F -

Faults 38  
  Alarm 40  
  Reset faults 40

## - G -

General information 7

## - H -

Handling 21  
  Transport 21  
Housing 14

## - I -

Illuminated LED strip 28  
Interfaces  
  USB interface 26

## - L -

Limit values ambient conditions 11

## - M -

Machine description 24  
  Electrical connections 25  
  Emission sound pressure level 12  
  Function 25  
Main operating modes 28  
Mains switch 13  
Maintenance 43  
  Error list 44  
  Maintenance plan 43  
Manual mode 34  
Mode  
  Automatic mode 35  
  Load program 32  
  Manual mode 34  
  Referencing 33  
  Switching off 36  
  Switching on 30

## - O -

Operating modes 28  
  Process observance 20  
Operating staff 16  
  Assembly staff 21  
  Commissioning staff 20  
  Main setter 19  
  Maintenance staff 21  
  Operator 18  
  Setter 19

## - P -

Preface 7  
Program  
  Load program 32

## - R -

Reference run 33  
Referencing 33  
Residual risks 12

## - S -

Safety	10
General description of the machine	12
Intended use	11
Residual risks	12
SAFE Method	10
Safety equipment	13
Safety information	10
Workplaces	14
Safety equipment	13
Emergency Stop Device	14
Housing	14
Mains switch	13
Warning signs	14
Safety relays	14
Software	28
Operating modes	28
Spare parts	46
Special operating mode Process observation !	20
Storage conditions	11
Supply circuit disconnecting means	13
Switching off	36
Switching on	30

## - T -

Transport	21
Types of faults	
Fault controller	38
Fault drive	38

## - U -

USB interface	26
---------------	----

## - W -

Warning signs	14
Workplaces	14



**Servomold GmbH & Co.KG**

Gewerbepark Gräsig 72

64711 Erbach

Germany

Phone: +49 6062 80933-0

Fax: +49 6062 80933-30

email: [info@servomold.com](mailto:info@servomold.com)

[www.servomold.com](http://www.servomold.com)